

CODE NUMBER

3453024

DESCRIPTION

1.5 gpf, Rough Brass Finish, Top Spud, Single Flush, 2-10.75 L Dimension, Hardwired, Sensor-Operated, Standard (not included, order separately) Wall Box, Royal® Concealed Sensor Hardwired Urinal Flushometer.

DETAILS

- Flush Volume: 1.5 gpf (5.7 Lpf)
- Finish: Rough Brass (RB)
- Power Type: Hardwired (HW)
- Valve: Diaphragm
- Valve Body Material: Semi-red Brass
- Fixture Type: Urinal
- Fixture Connection: Top Spud
- Rough-In Dimension: 14 ½" (368mm)
- Spud Coupling: 1 ¼" (32mm)
- Supply Pipe: 1" (25mm)
- L Dimension: 2" - 10 ¾" (51 - 273mm) (2-10-3/4-LDIM)
- Wall Box: Standard (not included, order separately)

FEATURES

- Flush volumes start as low as a pint of water
- Water conservation is aided by the ADA-compliant, non-hold-open handle, which, prevents urinal from exceeding intended flush volume
- Flush accuracy is controlled by CID™ technology, also enhancing water efficiency
- Durability is facilitated with high copper, low zinc brass castings for dezincification resistance
- Adjustable tailpiece
- PERMEX synthetic rubber diaphragm with Dual Filtered Fixed Bypass
- Valve body, Cover, Tailpiece and Control Stop shall be in compliance with ASTM Alloy Classification for Semi-Red Brass
- Valve shall be in compliance to the applicable sections of ASSE 1037.

VIDEOS

- ▶ [ESS Flushometer](#)



COMPLIANCES & CERTIFICATIONS



(UL Certified, ADA Compliant, cUPC Certified, BAA Compliant)

RECOMMENDED SPECIFICATION

Valve Body, Cover, Tailpiece and Control Stop shall be in conformance with ASTM Alloy Classification for Semi- Red Brass. Valve shall be in compliance with the applicable sections of ASSE 1037 and ANSI/ASME 112.19.2.

ELECTRICAL SPECIFICATIONS

- Arming Delay: 8 seconds

VALVE OPERATING PRESSURE (FLOWING)

15-80 PSI (103-552 kPa). Specific fixtures may require greater minimum flowing pressure - consult manufacturer requirements.

DOWNLOADS

- [Sloan Concealed Installation Instructions](#)
- [Control Stop Repair and Maintenance Guide](#)
- [Flush Connections Flanges Repair and Maintenance Guide](#)
- [Tail Piece Repair and Maintenance Guide](#)
- [Optima ESS Repair and Maintenance Guide](#)
- [Additional Downloads](#)

NOTES

All information contained within this document subject to change without notice.

Looking for other variations of the ROYAL 192 ESS product? [View the general spec sheet with all options.](#)

[Find a compatible urinal](#) for this flushometer.

[Find a compatible water closet](#) for this flushometer.

Sloan 10500 Seymour Ave, Franklin Park, IL 60131

Phone: 800.982.5839 • Fax: 800.447.8329 • sloan.com

ROUGH-IN

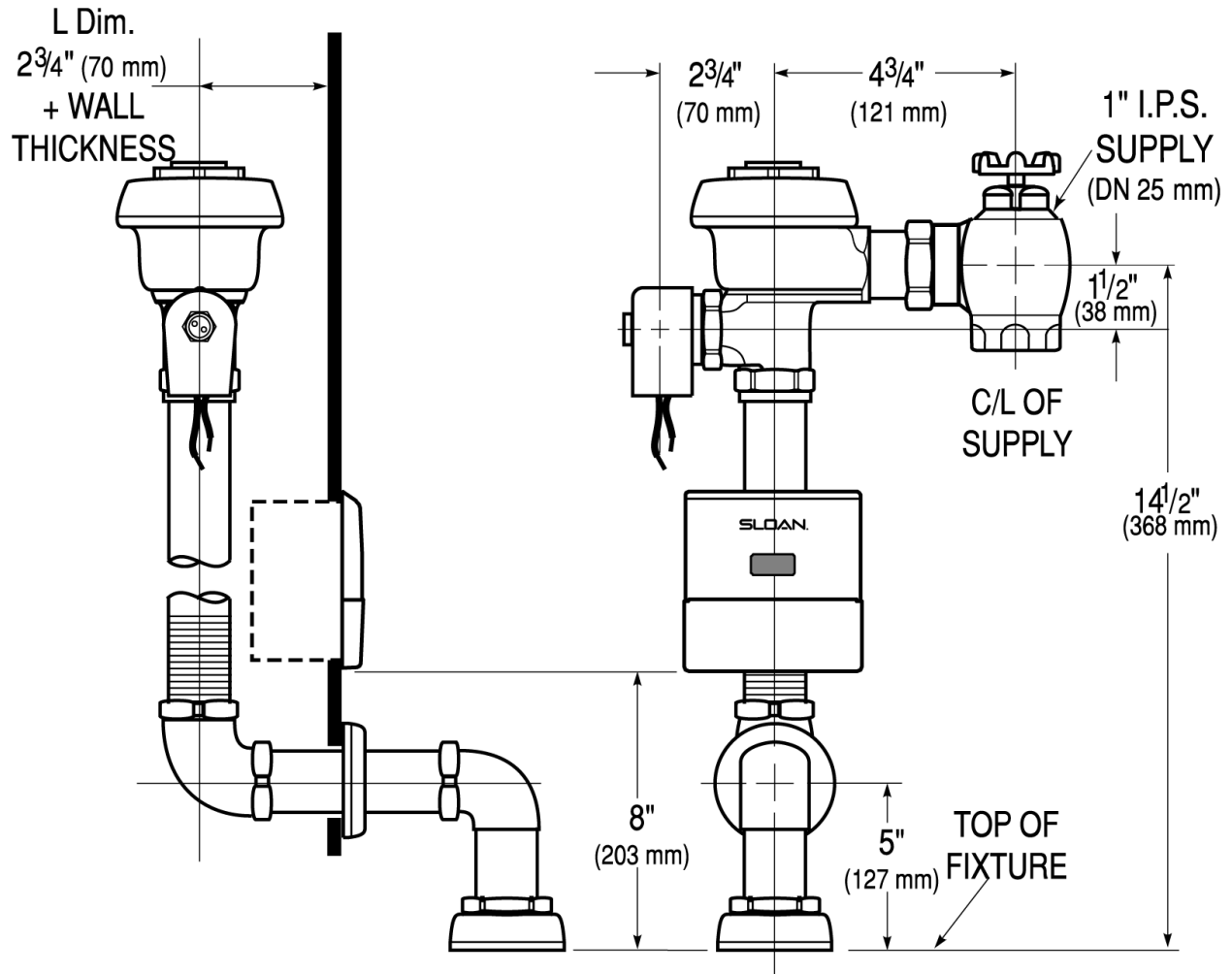

Sloan 10500 Seymour Ave, Franklin Park, IL 60131
 Phone: 800.982.5839 • Fax: 800.447.8329 • sloan.com